

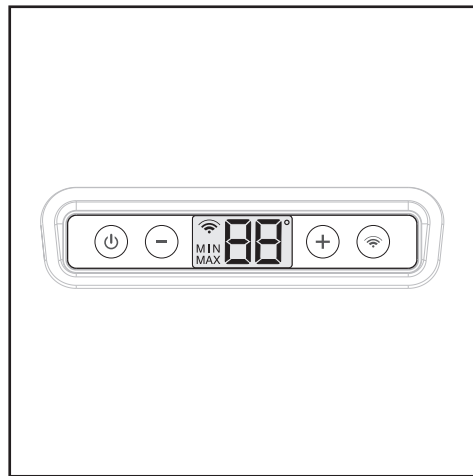

Italkero

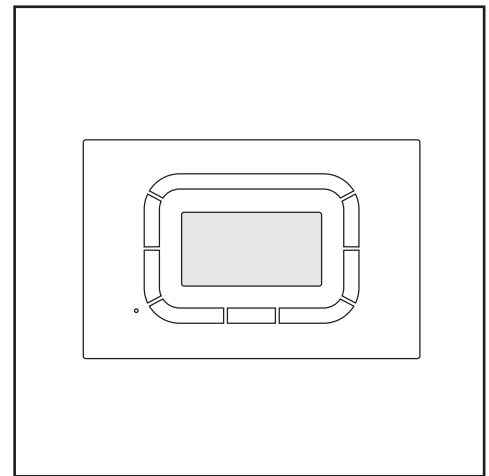

Manual



Radio chronothermostat
(Wireless)

USER INSTRUCTIONS

CONTENTS

BASIC SAFETY PRECAUTIONS	Pag. 4
GENERAL PRECAUTIONS	Pag. 5
MORE ABOUT THE MANUAL CONTROL	Pag. 6
- Description of keys	Pag. 6
- Description of display	Pag. 6
- Programming	Pag. 7
USING THE WIRELESS CONTROL	Pag. 12
- Description of keys	Pag. 13
- Programming	Pag. 13
COMMISSIONING	Pag. 22
SWITCHING OFF FOR LONG PERIODS	Pag. 24
CLEANING THE APPLIANCE	Pag. 24
MAINTENANCE	Pag. 25
TROUBLESHOOTING	Pag. 25

Dear Customer,

Thank you for preferring our appliance, a modern, top-quality and high-performance product designed to provide you with well-being, silent running and safety over the years.

All this will be yours above all if you entrust your Appliance to an Authorised After-Sales Service which is specifically trained to keep it operating at top levels of efficiency, using the Manufacturer's original spare parts.

You can also ask for the "Scheduled maintenance contract", with lower operating costs for you in case of need.

This instruction booklet contains important information and suggestions to help you use your appliance in the best possible way.

We thank you once again.

The appliance purchased by you
is covered by a **SPECIFIC WARRANTY**
starting on the date of validation by the Authorised
After-Sales Service in your area.

To find this log into our Website or phone
the manufacturer directly.

You are therefore warmly invited to promptly
contact the above After-Sales Service of the
Manufacturer which

FREE OF CHARGE

- will perform initial appliance start-up

- will validate the **WARRANTY CERTIFICATE**
provided with the appliance and which
you are invited to carefully read.

The After-Sales Service will offer suggestions
on how to use the appliance correctly

**Our appliances are
in conformity with:**

- Gas Directive 2009/142/CE
- Electromagnetic Compatibility Directive 2004/104/CE
- Low-Voltage Directive 2006/95/CE

 0476

In some parts of the manual, the following symbols are used:

 **IMPORTANT** = jobs requiring special caution and adequate preparation.

 **FORBIDDEN** = jobs that **MUST NOT** be performed.

BASIC SAFETY PRECAUTIONS

Please remember that certain basic safety precautions must be taken when using products requiring fuels and electricity:

⊖ - The appliance must not be used by children and disabled persons if unassisted.

⊖ - If you smell fuel, do not start electric appliances or appliances such as switches, household appliances, etc.

In this case:

- ventilate the premises by opening the doors and windows;
- close the fuel opening/closing device;
- promptly call the After-Sales service or professionally qualified personnel.

⊖ - Do not touch the appliance with wet or damp parts of the body or if your feet are wet.

⊖ - Cleaning is forbidden without first disconnecting the appliance from the power mains.

⊖ - Do not pull, disconnect or twist the power cables exiting from the appliance even when this is disconnected from the power mains.

⊖ - Do not place objects, curtains, etc., on the appliance which could cause malfunctions or prove to be a hazard.

GENERAL INFORMATION

⚠ This booklet and that for the Installer and After-Sales Centre are an integral part of the appliance and consequently must be looked after carefully and ALWAYS accompany it even when it is transferred to another owner or user or to another system.

In the event of its being damaged or lost, ask your Authorised Local Technical Centre for another copy.

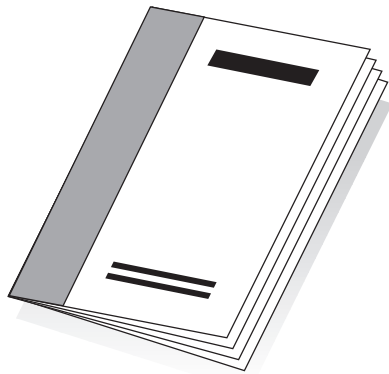

⚠ The appliance must be installed by a company approved in accordance with Law no. 46 dated 5 March 1990 which, once installation has been made, must issue a correct installation conformity certificate, pursuant to applicable national and any local regulations in accordance with Art. 17 of law no. 46/90 and the instructions provided by the Manufacturer in the installer's booklet provided with the product.



⚠ The appliance must be used as intended by the Manufacturer for the purpose for which it was specifically made.

The Manufacturer disclaims all contractual and non-contractual liability for injury caused to persons and animals and damage to things caused by installation, adjustment and maintenance errors or by improper use of the appliance.

⚠ - If the appliance is not used for a long period of time, the following operations must be performed:

- position the master switch of the system, if fitted, on "off" or remove the plug from the mains power socket;
- close the fuel tap.

KNOW MANUAL COMMAND

- 1 - On/Off key and device RESET
- 2 - Reduce temperature key (MIN 5°C)
- 3 - Light display
- 4 - Increase temperature key (MAX 35°C)
- 5 - Enable/disable Wireless command key

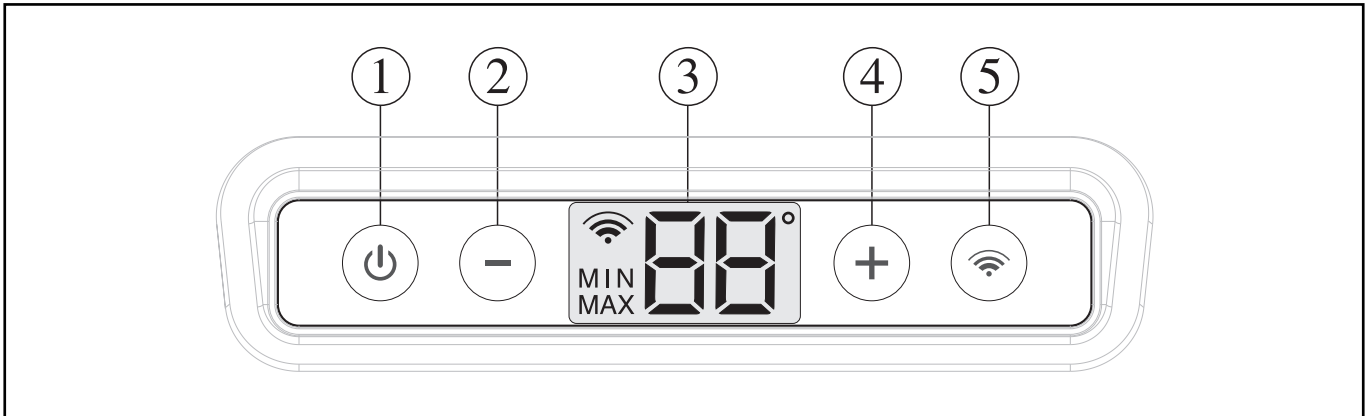

DESCRIPTION OF DISPLAY

This type of screen simultaneously provides an entire series of information:

- MIN operating power.
- MAX operating power.
- Wire command enabling.
- ambient temperature.
- desired ambient temperature.
- degrees centigrade unit scale.
- data transmission

DESCRIPTION OF ICONS

- 1 - operation at MAX power.
- 2 - operation at MIN power.
- 3 - data transmission between the device and the Wireless command (intermittent icon).
- 3b - Wireless command enabled (fixed on icon).
- 4 - Detected ambient temperature.
- 4b - Desired ambient temperature.

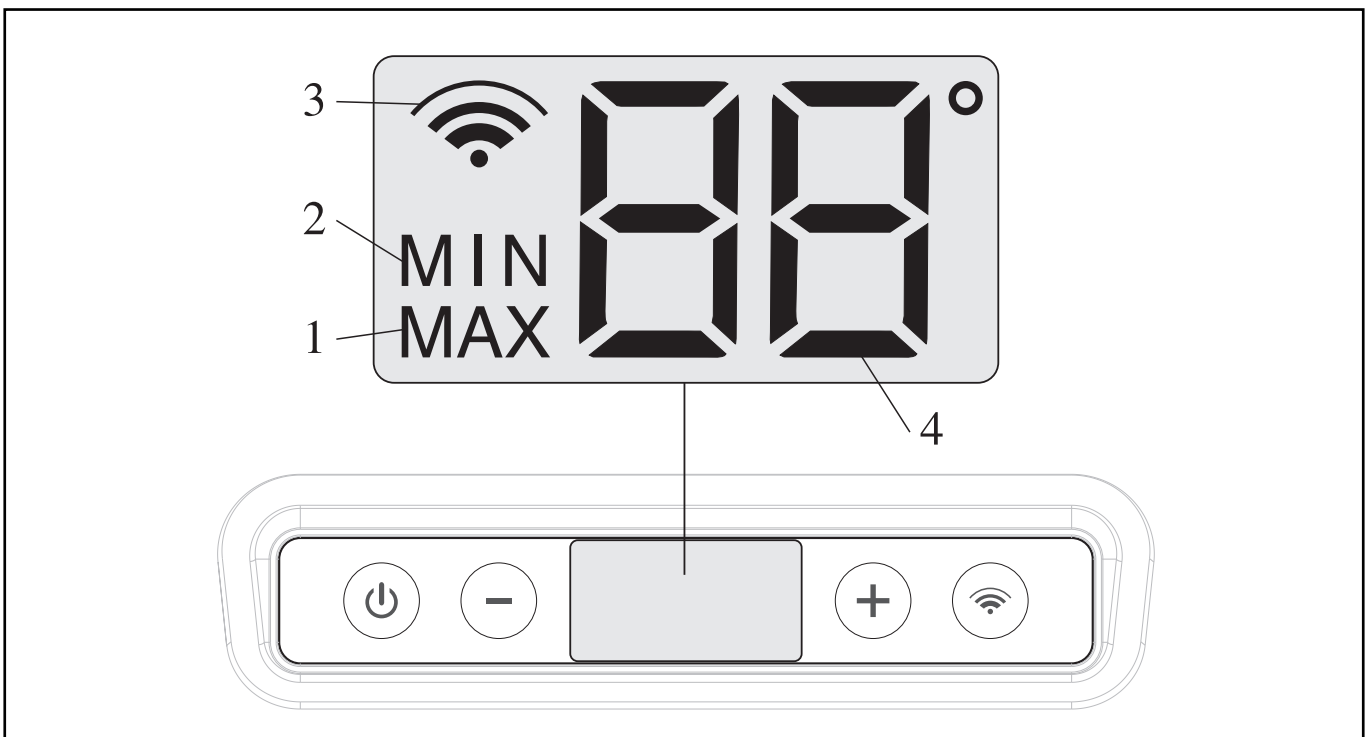

PROGRAMMING

In the event of a power cut, the command maintains in the memory the operating status (normal or with ERROR CODE), when electrical power returns the previous operation continues.

• START-UP

- Press the On/Off key, the display lights up and the device starts.

The display is backlit only when the command is used. It switches off automatically after approximately 3 seconds.

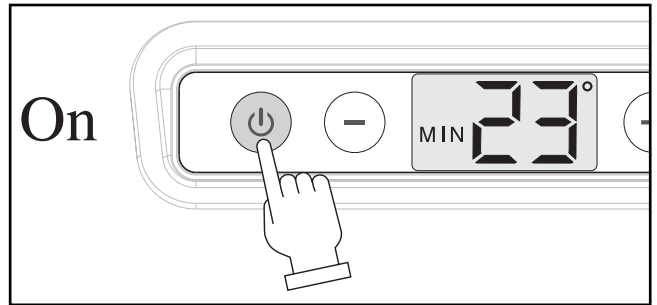

• SWITCH-OFF

- Press the On/Off key, the display lights up and the device switches off.

The display is backlit only when the command is used. It switches off automatically after approximately 3 seconds.

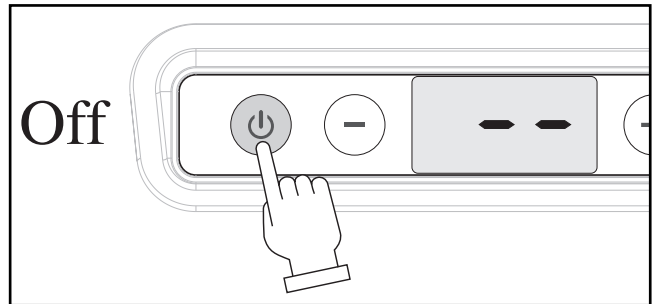

• TEMPERATURE ADJUSTMENT

With the device on:

- Press the "+" or "-" key, the display lights up to flash the temperature which is already set.

- Press the "+" or "-" key to set the new desired temperature.

With the device off:

- Press the "+" or "-" key, the display lights up to flash the temperature which is already set.

- Press the "+" or "-" key to set the new desired temperature which will be enabled as soon as the device switches on.

A degree before (-1°) reaching the desired temperature, the device passes from MAX to MIN power in automatic mode. Instead, if the desired temperature is exceeded by a degree (+1°), the device stops.

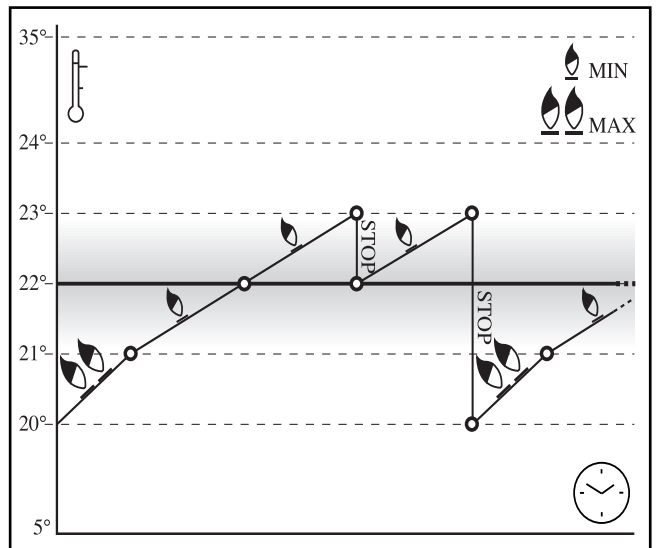
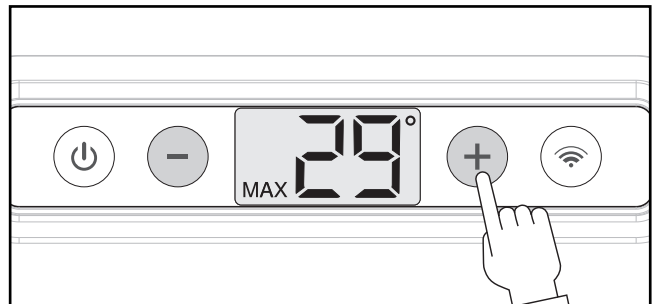

Temperature adjustment determines the type of device operation: heating or summer ventilation.

HEATING

This function allows an operating temperature that starts from 5°C to 35°C.

- Press the On/Off key.
- Press the "+" or "-" key to choose the desired temperature.

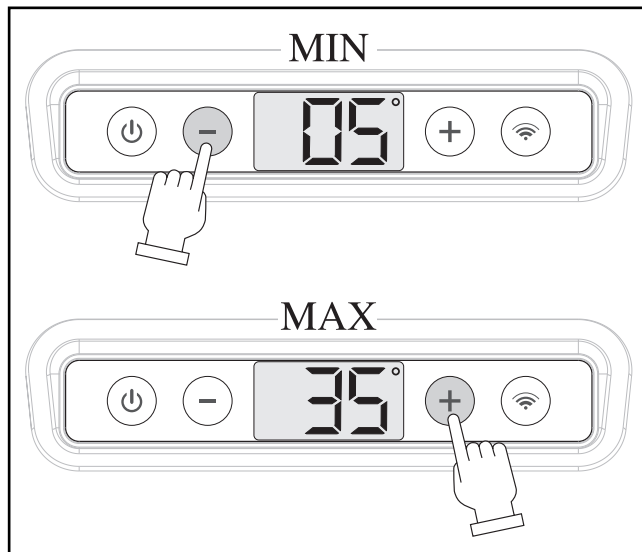

SUMMER VENTILATION

(only managed by wireless command)

This function only uses the tangential fan at MIN or MAX power and activates under 5°C.

- Press the On/Off key.
- Press the "-" key to set the temperature at 5°C.
- Press the "-" key to go under 5°C and then choose the desired speed of the fan (MIN or MAX).
- Press the "+" key to bring the temperature over 5°C and exit summer ventilation.

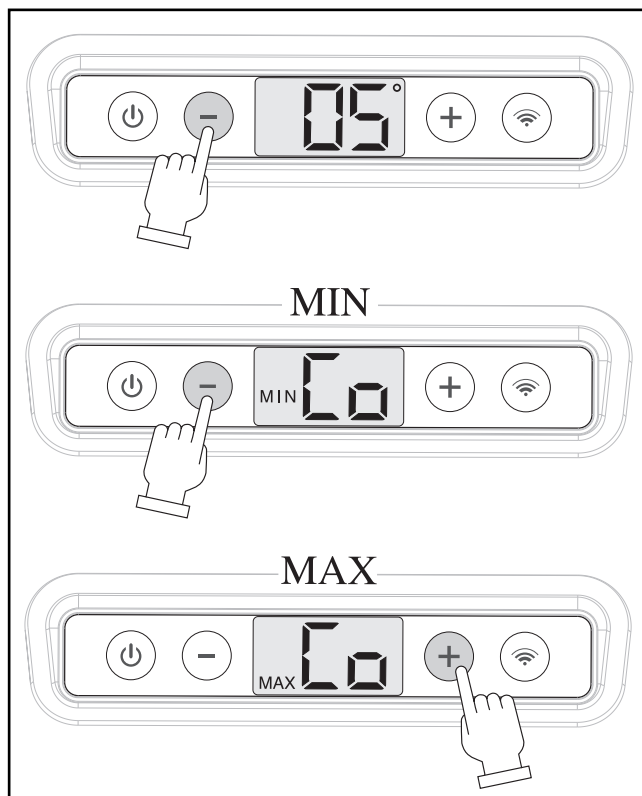

• **HIDDEN FUNCTIONS: MIN POWER - MAX POWER - SLEEP TIMER**

This hidden function enables adjustment of the MIN and MAX power level (only for Technical Support), by doing so any ambient probe fault is ignored and the burner function is forced to check the modulation parameters. The SLEEP TIMER function (for the User) enables setting the device automatic switch-off.

With the burner on or off:

- Connect the gauge on the device.
- Press "+" and "-" (2 + 4) together for MIN 10 seconds.
- "ON" and MIN appear on the display, set the MIN pressure by rotating the adjustment screw (9) on the valve.
- Press the "Wireless" key (5) to continue.
- "ON" and MAX appear on the display, set the MAX pressure by rotating the adjustment screw (8) on the valve.
- Press the "Wireless" key to continue.
- On the display "H-" and "00" appear flashing alternatively (operating hours set, Sleep Timer function).

With the Sleep Timer function enabled, you can change the temperature and switch off the device.

- Press "+" or "-" to set the number of operating hours (from MIN 1 to MAX 12).
- Press the "Wireless" key to continue.
- Press "+" and "-" together (2 + 4) for MIN 10 seconds to save the modified parameters and exit the Hidden Function.

⚠ The "hidden function" is timed, after 0 minutes without pressing any key and without confirming the new values ("+" and "-" keys together for MIN 10 seconds), the device exits programming and maintains the previous values.

⚠ Sleep Timer, once inserted this function always stays on and on each switch-on of the device, to disable it, simply enter the Hidden Functions and set the number of hours to "00".

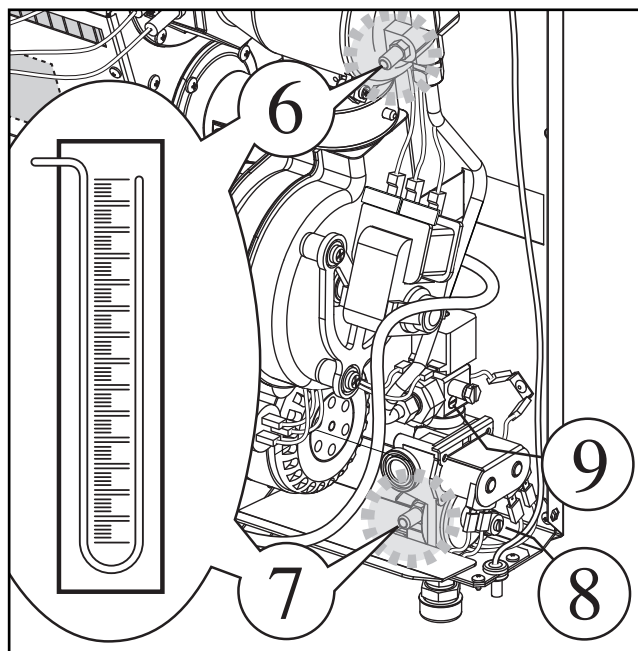
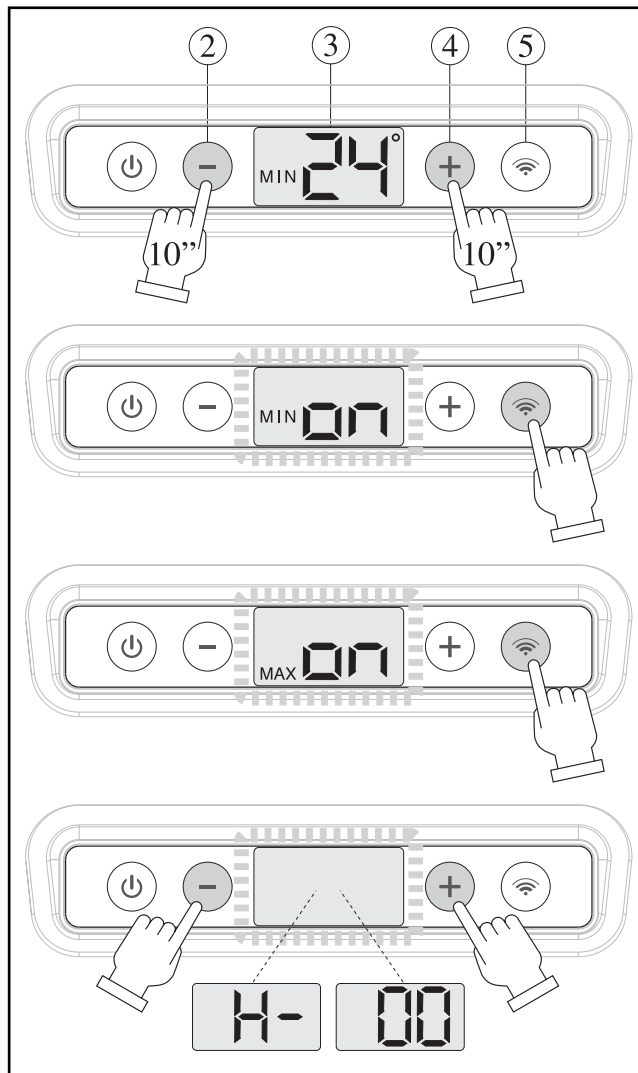

• WIRELESS COMMAND ENABLING

- Switch on the device.
 - Activate the Wireless command inserting the batteries.
 - Press the Wireless key (5) for MIN 3", the wireless icon flashes.
 - The device searches the nearest Wireless command, as soon as it finds it, it is automatically recognised and the wireless icon remains on and fixed.
- From now on, the device is managed by the wireless command and there will be two types of screens:
- A (device on), HT (Heating) and MIN or MAX (power).
 - B (device in stand-by), OF (Off), the device is not off but in standby for the wireless command to re-activate it to reach the desired temperature.

⚠ If communication between the device and the remote chronothermostat is interrupted for more than 5 seconds (e.g. battery discharge), the device goes in standby while waiting for a new wireless signal. The device never disconnects from the remote chronothermostat until the user decides to do so.

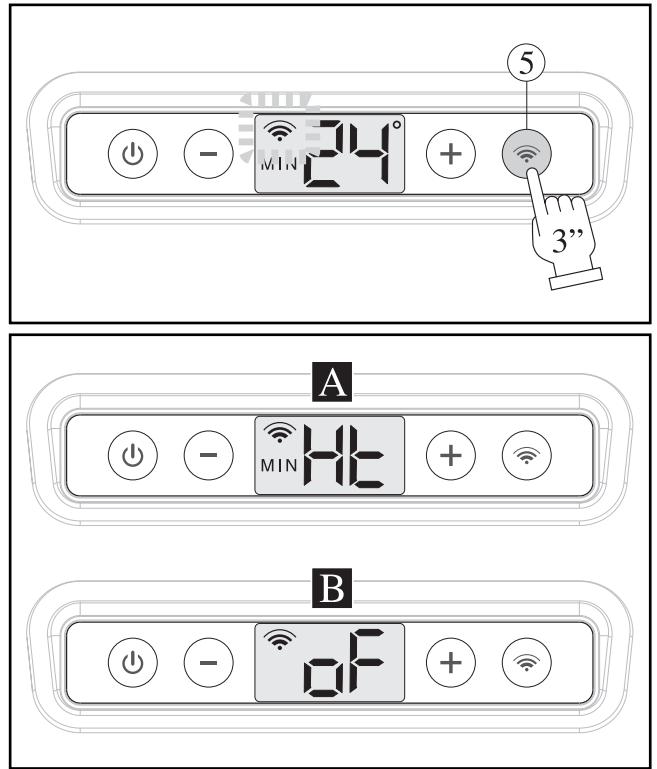

• ASSIGN WIRELESS ADDRESS

- Switch on the device.
- At the same time press the 4 + 5 keys for 10 seconds, the digits "00" flashes.
- Press the "+" and "-" keys to set the same value already assigned to the remote chronothermostat.
- Press the 4 + 5 keys for 10 seconds to confirm and return to the main menu.

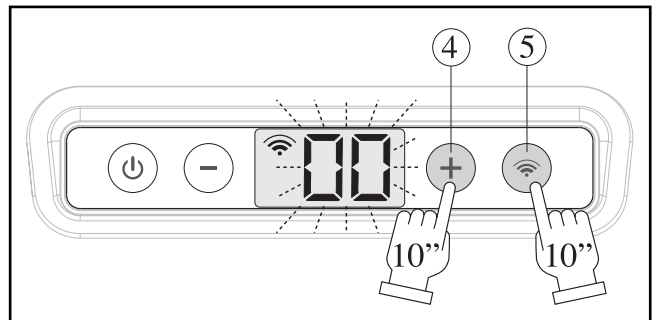

• KEYPAD LOCK

- Switch on the device.
- Simultaneously press the 2 + 5 keys for 3 seconds, the letters "SE" (security) flash, whatever key is pressed "SE" appears.
- At the same time, press the 2 + 5 keys for 3 seconds to release the keys.

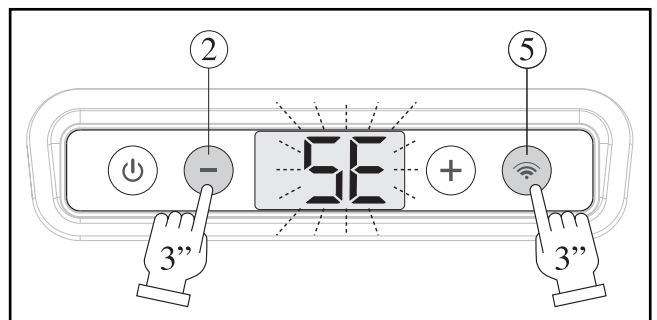

Wireless radio chronothermostat
WIRELESS

(optional, can also be purchased subsequently)



**For the use and control of all gas appliances
in the range made by the Manufacturer.**

ABOUT THE RADIO WIRELESS CHRONOTHERMOSTAT

The use of this control allows:

- the best positioning of the detection sensor (on wall or table base) for controlling the actual room temperature;
- the possibility of controlling several appliances in the same room;
- programming daily and weekly operation.

Wireless radio chronothermostat without wires:

- one of a kind as regards ease of use and the control of all the operating modes;
- distinguished by a **large graphic Display** unit that helps the user to make the various control and adjustment settings;
- uses an "NTC" sensor that allows controlling/setting even the smallest room temperature variations (0.5°C), while maintaining the difference in temperature, between switch-off and switch-on, within about 1°C.

Can also be purchased and used in a previously-installed appliance.

DIMENSIONS AND INSTALLATION

To install the chronothermostat, you need to:

- release the front with the display keeping the hook pressed (PUSH key) then rotate upwards separating it from the rear.
- mark and create holes and fasten the chronothermostat on the wall.
- re-assemble the front with a compass movement, but downwards until you hear a locking CLICK.

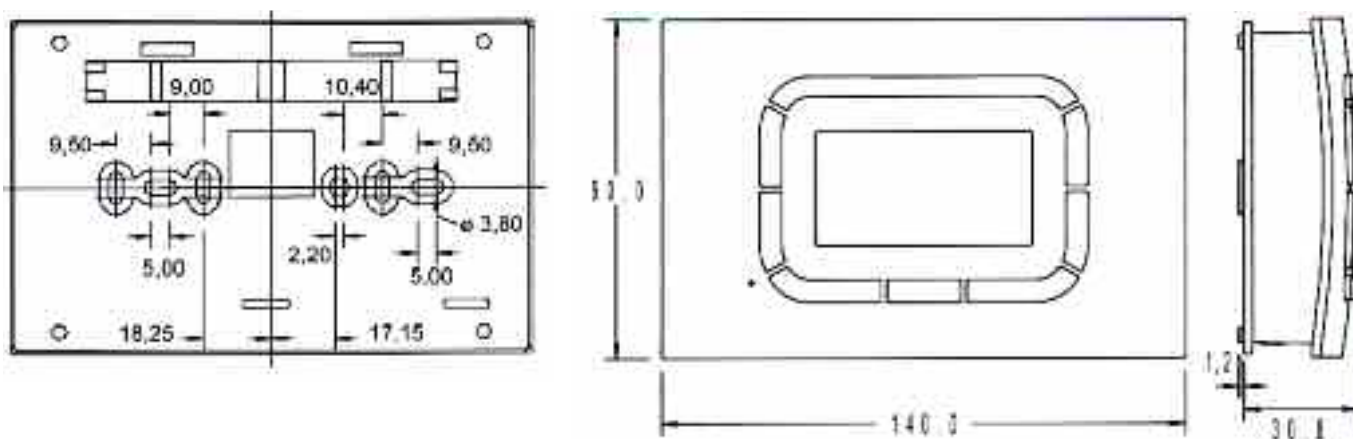
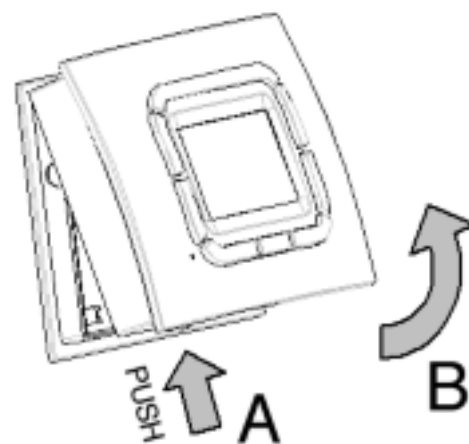

⚠ -Carefully read the following instructions as these provide important information on installation and correct use of the Remote Control.

⚠ -The installer is kindly asked to give this booklet to the end user and to invite him/her to read its contents.

⚠ -In case of malfunction or faults during the warranty period, contact the Manufacturer's Authorised Technical Assistance Centre only.

USE OF WIRELESS COMMAND

DESCRIPTION OF THE KEYS

- 1 - Function/parameter selection key
- 2 - Function/parameter selection key
- 3 - Reset
- 4 - Function key (NO, ESC, etc.)
- 5 - Multi-function transparent key
- 6 - Function key (OK, VENT, etc.)
- 7 - Display
- 8 - Temperature DECREASE key
- 9 - Temperature INCREASE key

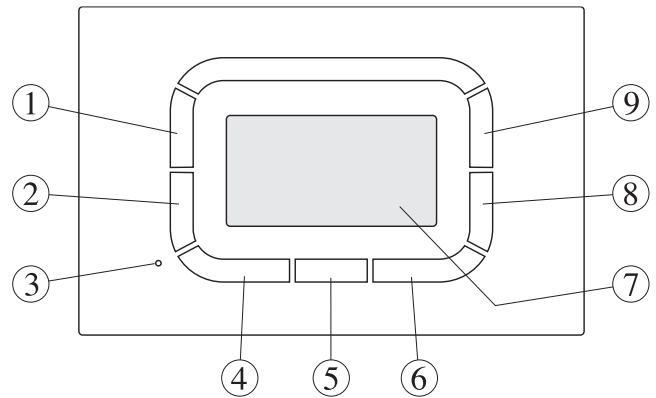

GENERAL FEATURES

- Exclusive design
- graphic LCD 128x64 pixel
- timed backlighting 10 s
- LED for diagnostics/signals
- 7 variable function keys
- weekly programming
- 4 temperature levels (T0, T1, T2, T3)
- settable ambient temp resolution: 0.5°C
- measured ambient temp resolution: 0.1°C
- programming interval: 15 minutes

TECHNICAL DATA

- Power supply: using 2 mini AAA x 1.5V batteries
- Communication: RF 868 MHz
- Operating temperature: 0°C +50°C
- Humidity: 95% maximum at 40°C
- Level of protection: IP30
- Dimensions: 140x90x32 mm

• before start-up: language setting, date and time

- insert the batteries
- press keys 1 or 2 to choose the language
- press key 6 OK to confirm
- press keys 8 or 9 to choose the day
- press key 2 to move on the time line
- press keys 8 or 9 to choose the time
- press key 2 to move on the minutes line
- press keys 8 or 9 to set the minutes
- press key 6 OK to confirm

To exit programming without changing the date and time, press ESC.

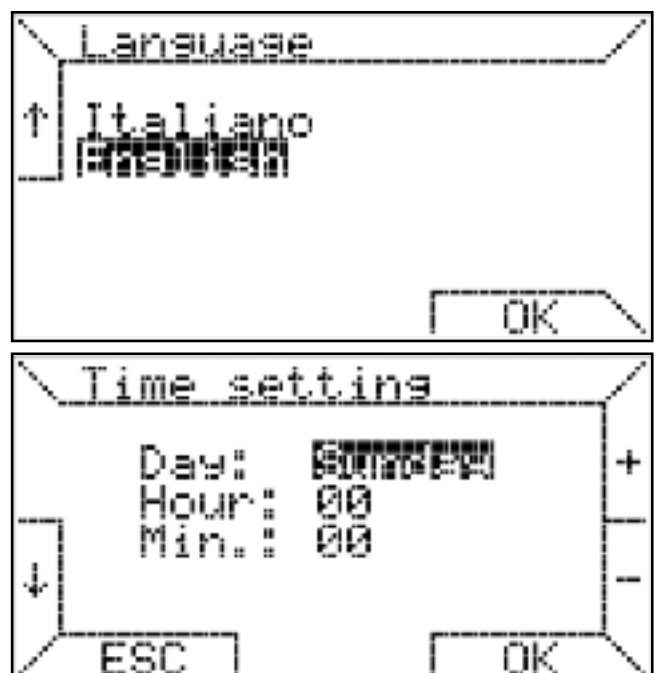

• **basic functions**

Having set the language, date and time, a screen appears that shows:

- on top, the current day and time
- below, the ambient temperature (measured every minute)
- on the right, the operating mode icon (e.g. Automatic)
- on the bottom, the operating periods of the device. The 24 hours are divided into intervals of 15 minutes for 4 programmable temperature levels (T0, T1, T2 and T3).

Beside the operating icon, a flame switches on to signal ignition of the burner: 4 types of flames from small to big, according to the power requested.

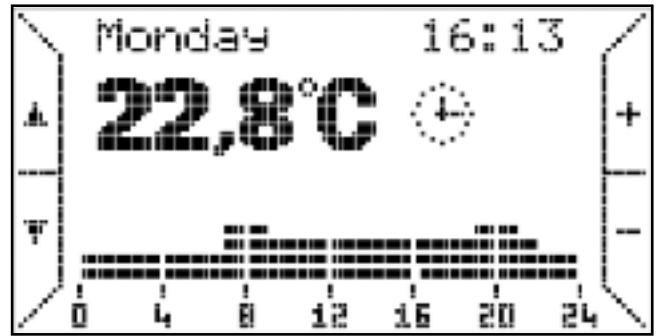

• **operating mode**

AUTOMATIC: the chronothermostat executes the thermo-regulation program set for the current day. On the bottom of the display the switch on and off programmed periods are displayed.

- press key 2 to choose this function and key 6 OK to enter.
- press keys 8 or 9 to change the four programmable levels (T0, T1, T2 and T3).
- press keys 1 or 2 to move on the desired line (T0, T1, T2 and T3) and key 6 OK to confirm.

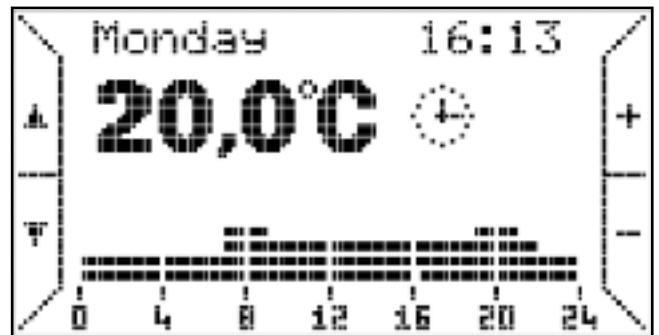
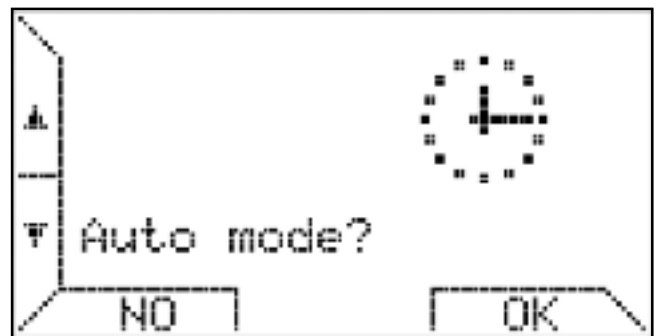

MANUAL: ambient thermo-regulation according to a temperature selected by the user (thermostat function).

- press key 2 to choose this function and key 6 OK to enter.
- press keys 8 or 9 to set the desired temperature.
- press key 6 OK to confirm and exit.

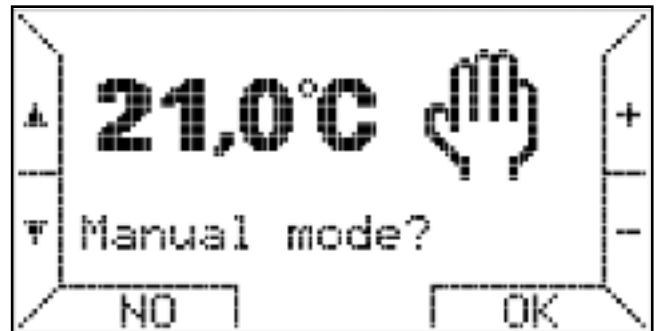

SUMMER: ambient heating function disabled.
 Summer ventilation manually enabled.
 - press key 2 to choose this function.

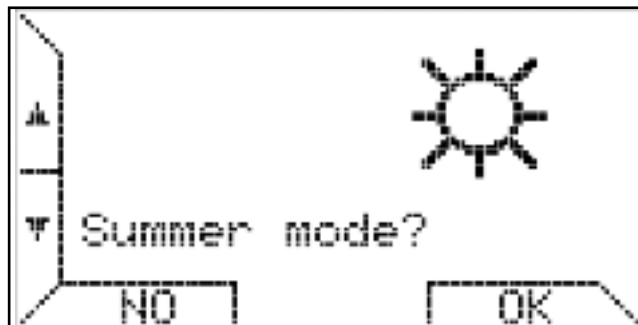

- press key 6 to choose VENT.



- press key 5 to choose high speed (HIGH) or low speed (LOW).



HOLIDAYS: thermo-regulation, enabling the desired temperature to be maintained for a number of days set by the user (thermostat function).

- press key 2 to choose this function and key 6 OK to enter.

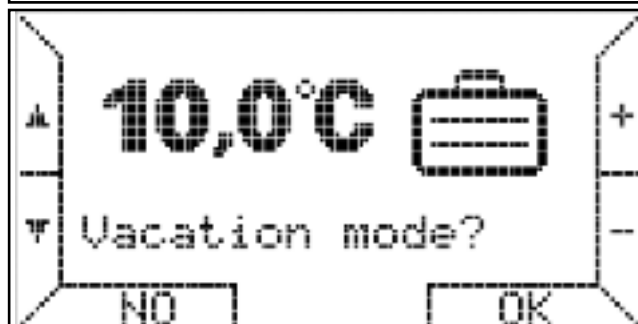

- press keys 8 or 9 to set the desired temperature.

- press key 6 OK to confirm.



- press keys 8 or 9 to set the number of desired days (max. 99 days).

- press key 6 OK to confirm.

If you press ESC or OK without setting the number of days, the "HOLIDAY" mode does not activate and the chronothermostat returns to the previous mode.

When the period set is up, when the counter returns to zero, the chronothermostat passes to "automatic" mode and follows the already set weekly program.



SETTINGS: allows the user to manage the ambient thermo-regulation, including the weekly program executed by the chronothermostat as well as configure the operating parameters.

- press key 2 to choose this function and key 6 OK to enter.

- press key 6 OK, you enter PROGRAMMING (weekly).

- press key 6 OK, you enter TEMPERATURE (setting T0-T1-T2-T3).

- press keys 1 or 2 to go to the desired line T0-T1-T2-T3.

- press keys 8 or 9 to set the desired temperature (MIN 1°C and MAX 30°C).

The programming logic combines the MIN temperature with T0 and the MAX with T3.

The chronothermostat complies with the following constraint: "T0 ≤ T1 ≤ T2 ≤ T3" and automatically redimensions all the temperatures input by the user.

- press key 6 OK to confirm and return to the PROGRAMMING menu.

- press keys 1 or 2, choose DAY PROGRAMMING and press key 6 OK.

- press keys 8 or 9 to choose the desired day and press key 6 OK.

- press keys 8 or 9 to set the start time (intervals of 15 minutes) and press key 6 OK.

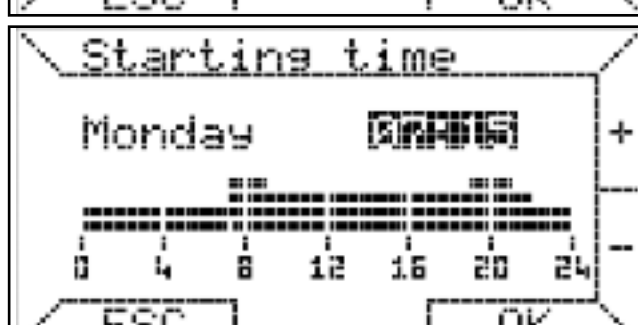
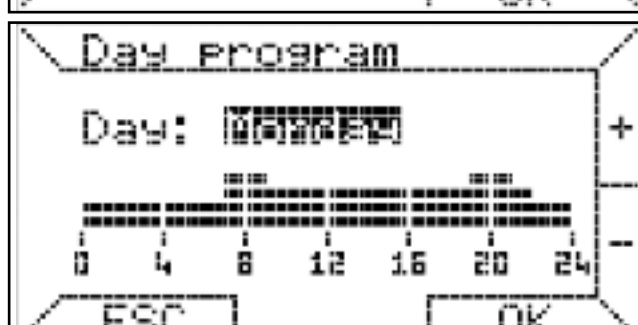
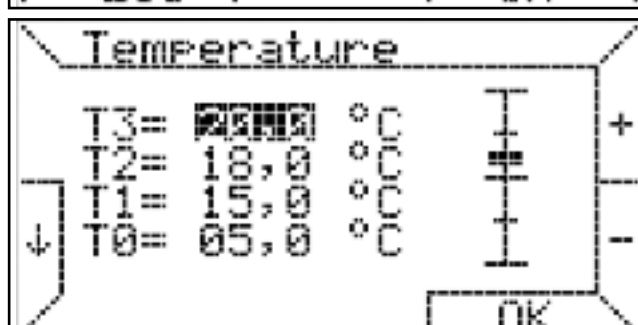
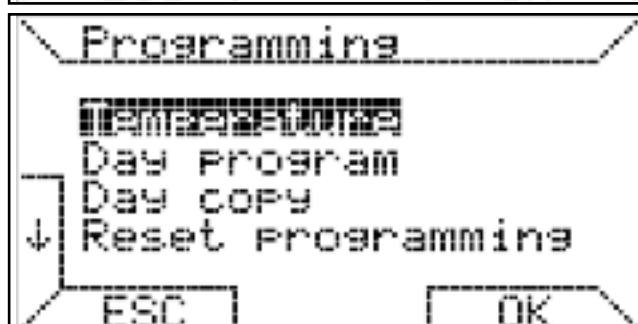
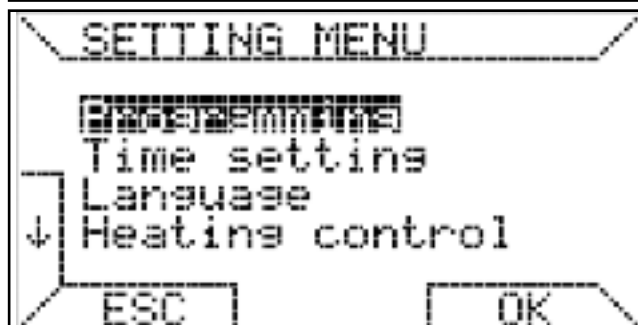

- press keys 8 or 9 to choose the temperature range (T0-T1-T2-T3) and press key 6 OK to assign it to the just set time.

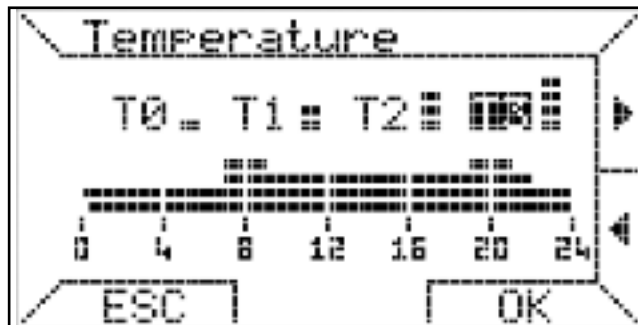

- press keys 8 or 9 to set the end time (intervals of 15 minutes) and press key 6 OK. The start and end times must always differ with the end time after the start time.

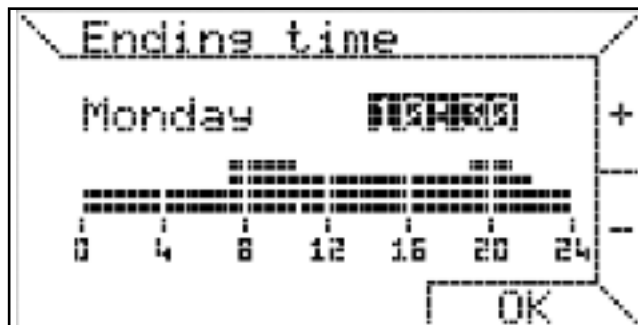

This function allows copying of the program for a day onto another or on all days.

- press keys 1 or 2 to select COPY DAY and press key 6 OK.

- press keys 8 or 9 to choose the source day to copy (Monday) and press key 6 OK.

- press keys 8 or 9 to choose the destination day (Tuesday) and press key 6 OK.

- to confirm the operation was successful, the following message appears: Copied!

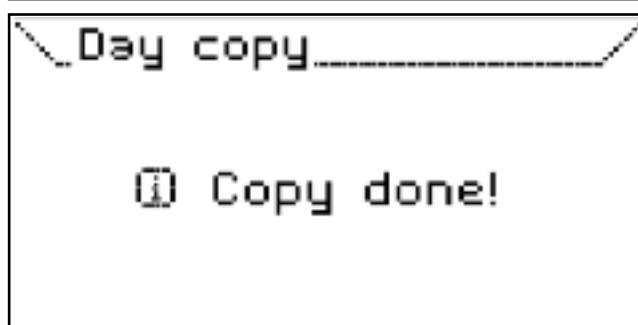
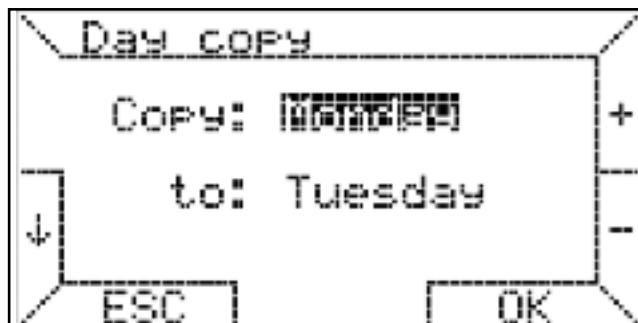

PROPORTIONAL: thermo-regulation method that regulates the system power percentage based on the difference in the desired and measured ambient temperature.

The power percentage, in this case, will be proportional to the difference in these two temperatures according to the following rule

if $T_a \leq T_{ap} - 2 + \text{offset}$ then $P = 100\%$
 if $T_{ap} - 2 + \text{offset} < T_a < T_{ap}$
 then $T_i = (\text{max} / 2) \times (T_{ap} - T_a + \text{offset})$
 if $T_a \geq T_{ap}$ then $P = 0\%$
 request made again if $T_a \leq T_{ap} - 0.5$

legend:

P = power percentage that varies from 0% to 100%,
 T_i = heating set-point,
 T_{ap} = programmed ambient temperature,
 T_a = measured ambient temperature,
 offset = correct value (settable),

The role of the offset (settable from 0 to 1°C) is "to move" the band so that corresponding to $T_a = T_{ap}$ a higher power percentage can be obtained without working on the T_{ap} .

Given the offset default value=0, the band has a range of 2°C and is centred in $T_{ap}-1$.

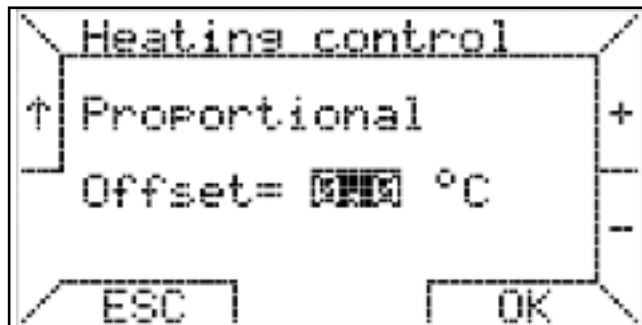

ON/OFF: similar method to that used by the chronothermostats with clean contact.

Having defined the hysteresis value, settable between 0 and 1°C (default 0°C), thermo-regulation takes place according to the following rule:

if $T_a \leq T_{ap} - \text{hysteresis}$ then $P = 100\%$
 if $T_a \geq T_{ap} + \text{hysteresis}$ then $P = 0\%$

legend:

T_i = heating set-point,
 T_{ap} = programmed ambient temperature,
 T_a = measured ambient temperature,
 offset = correct value (settable),
 P = maximum value that the heating set-point can have (set by user).

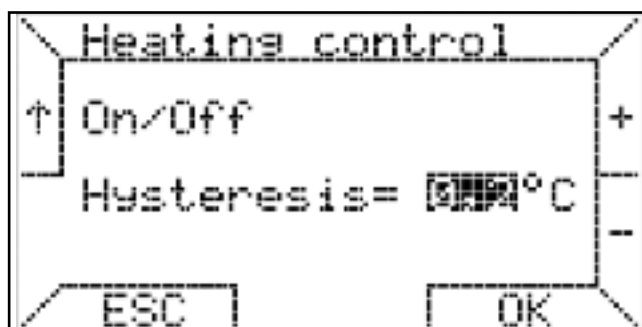

Display: this function allows you to set the time in which the display remains on before returning to the low consumption status. You can keep the display always on to the detriment of the duration of the batteries.

- press keys 1 or 2 to select Display.
- press keys 8 or 9 to choose the time value or NEVER (always on).
- press key 6 OK to confirm.

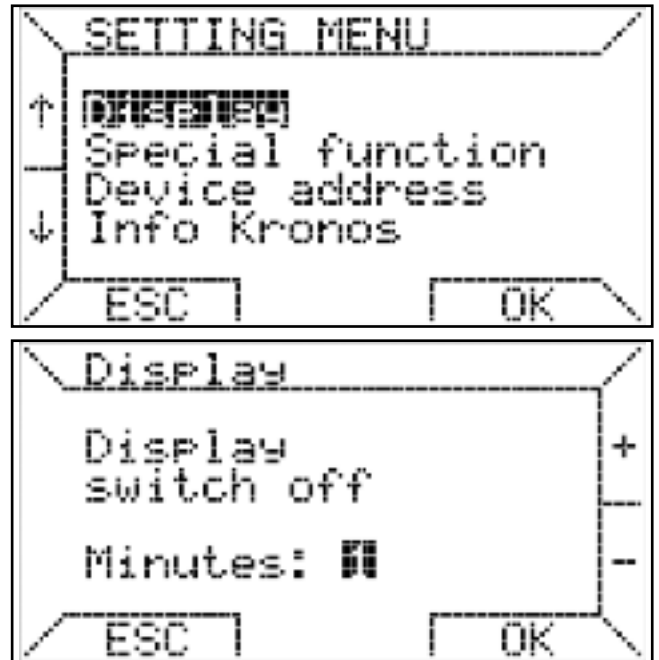

SPECIAL FUNCTIONS

• **combine the command with one or more devices.**

This chronothermostat can be combined with one or more devices installed in the same environment or in adjacent ambients (case A or B).

- press keys 1 or 2 to select MENU SETTINGS and press key 6 OK.
- press keys 1 or 2 to select ADDRESS MODULE and press key 6 OK.
- the PASSWORD 00 appears, **enter number 195** and press key 6 OK.

The password is 195 and cannot be changed.

To set 195, press keys 1 and 2 to enter the tenths and keys 8 and 9 for the units.

- press keys 8 or 9 to select the ADDRESS number desired (between 00 and 99) and press key 6 OK.
- Example: setting number 33, the chronothermostat will command one or more devices with address 33.

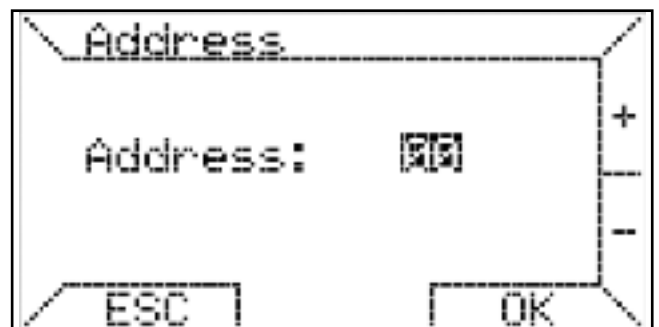
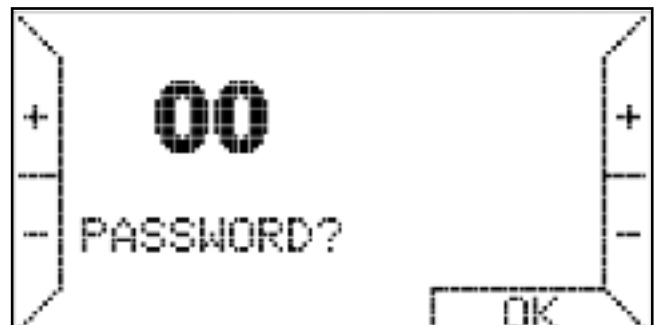
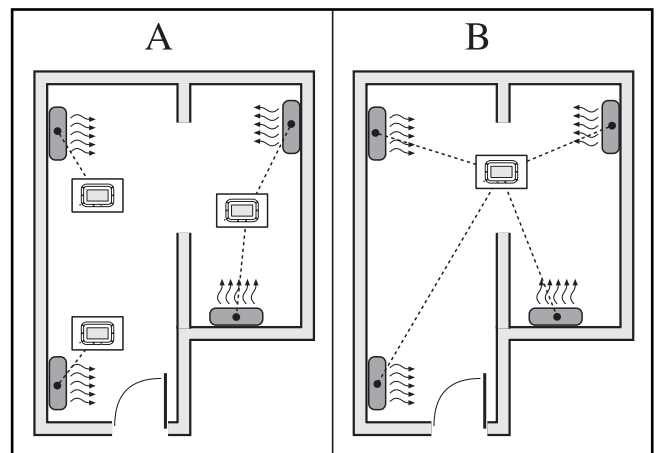

• **power always on MIN**

With the function on, the device always works with MINIMUM power.

- press keys 1 or 2 to select MENU SETTINGS and press key 6 OK.
- press keys 1 or 2 to select SPECIAL FUNCTIONS and press key 6 OK.
- the PASSWORD 00 appears, **enter number 195** and press key 6 OK.
- press keys 1 or 2 to go to **GAS** line.
- press keys 8 or 9 to choose LOW.
- press key 6 OK.

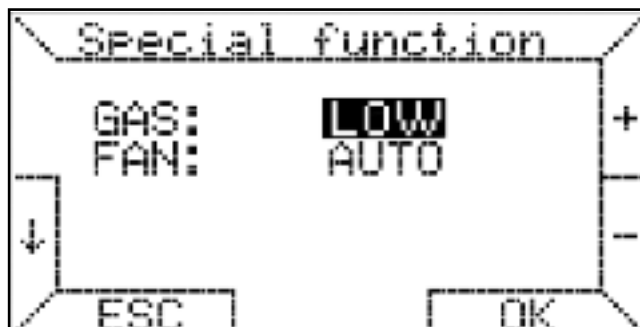
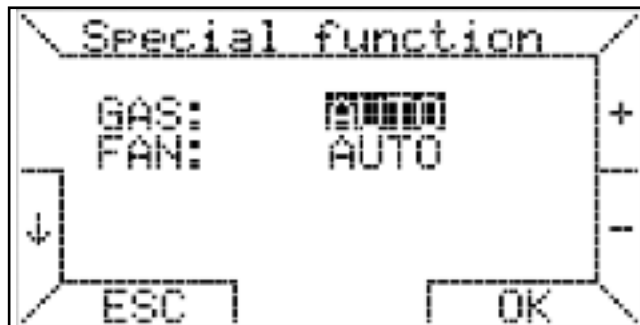

• **fan speed always on MAX**

With this function active, the speed of the fan is always on MAXIMUM.

- press keys 1 or 2 to select MENU SETTINGS and press key 6 OK.
- press keys 1 or 2 to select SPECIAL FUNCTIONS and press key 6 OK.
- the PASSWORD 00 appears, **enter number 195** and press key 6 OK.
- press keys 1 or 2 to go to the **FAN** line.
- press keys 8 or 9 to choose HIGH.
- press key 6 OK.

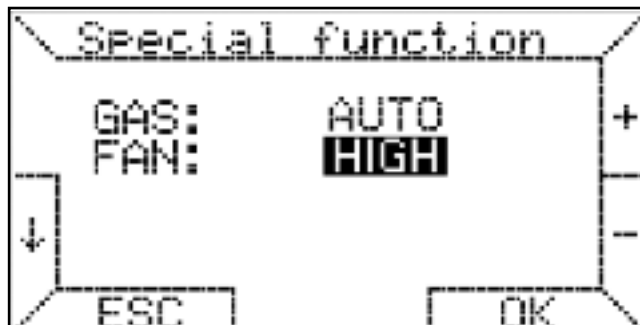
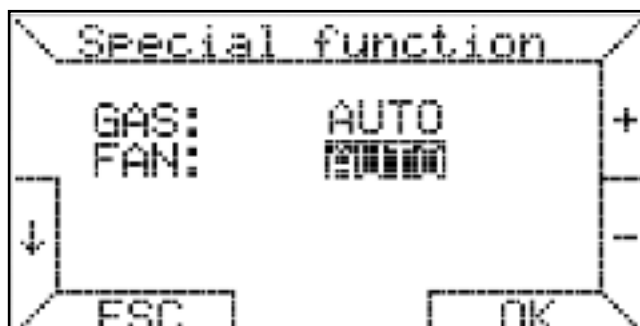

• **information on chronothermostat**

INFO KRONOS, this function lists some of the settings of the chronothermostat: product code, software version, power percentage, battery loading percentage (66) and address set (03).

- press keys 1 or 2 to select the MENU SETTINGS and press key 6 OK.
- press keys 1 or 2 to select the INFO KRONOS and press key 6 OK to exit.

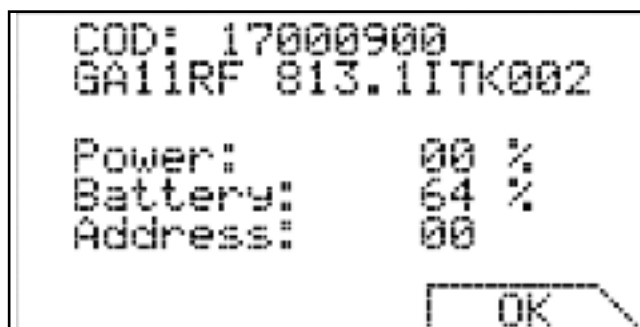

• keypad lock

This function blocks use of all the keys by avoiding accidental changing of the parameters already set.

- simultaneously press keys 1 and 8 to activate the keypad lock, the writing "keypads locked" appears.

- pressing one or more keys the KEYS LOCK FUNCTION ON screen appears.

- press keys 1 or 8 simultaneously to unlock the keypad

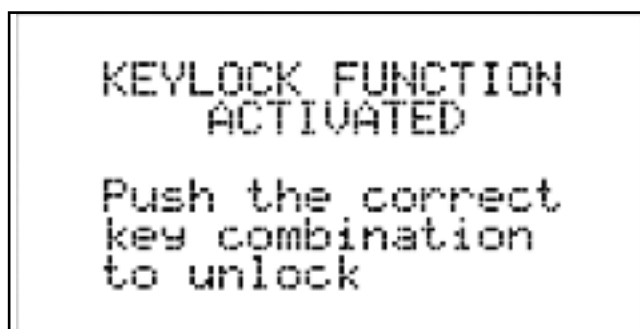
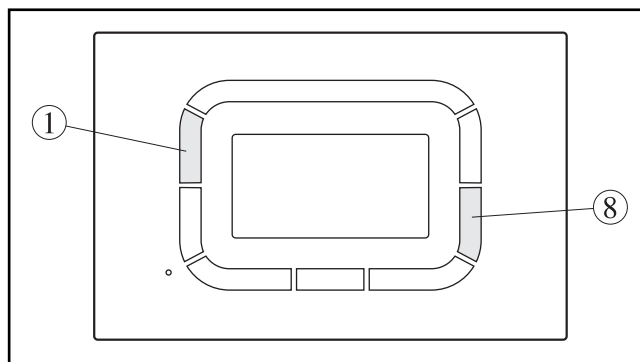

SAVING DATA IN THE CHRONOTHERMOSTAT MEMORY

The chronothermostat saves certain data in the memory so they don't have to be reset when the batteries are replaced. The following are saved: the weekly program and the 4 temperatures (T0,T1,T2,T3) if changed for the automatic operating mode, the address of the radiofrequency and the special functions value.

To recharge the weekly program and the 4 default temperatures (T0,T1,T2,T3):

- press keys 1 or 2 to select the MENU SETTINGS and press key 6 OK.

- press keys 1 or 2 to select PROGRAMMING and press key 6 OK.

- press keys 1 or 2 to select PROGRAM RESET and press key 6 OK.

ATTENTION: press the reset key (3), the weekly program, the 4 temperatures (T0,T1,T2,T3), the address assigned and the value of the special functions are not reset.

WARNINGS FOR INSTALLATION

Always comply with the electrical safety standards in the country of intended installation.

Before operation, check the two alkaline batteries (type AAA LR03 1,5V) are correctly placed, respecting polarity.

Avoid exposing the system to dripping water.

COMMISSIONING

The appliance must be started for the first time by the Technical Assistance Centre authorised by the Manufacturer, after which it can operate in the mode preferred by the user, manual or automatic. It may however be necessary to start up the appliance independently, without involving the Assistance Centre; for example, after a period of absence or prolonged stoppage. In these cases, perform the following inspections and operations:

WINTER OPERATION

- Open the gas tap.
- Operate the master switch of the power mains or connect the power plug to the appliance.
- Press the On/Off key to start the appliance, the display automatically illuminates.
- Press the "+" or "-" to set the desired temperature, after about 3 seconds the display goes off automatically.

⚠ Turning on or off the display NOT determines the switching on and off of the unit. The unit is on or off just by pressing the On / Off.

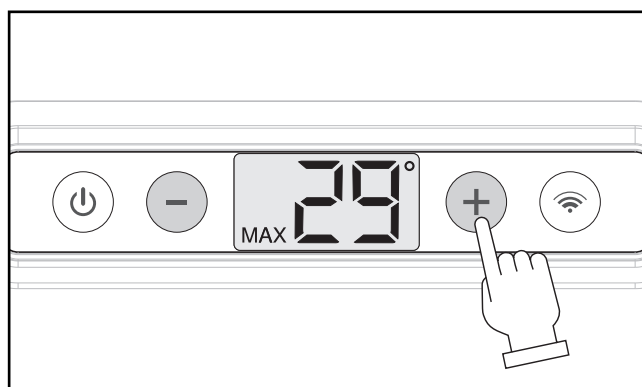
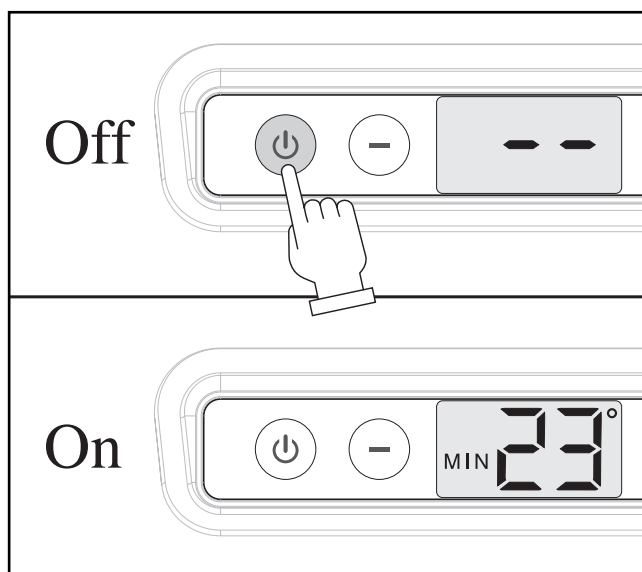
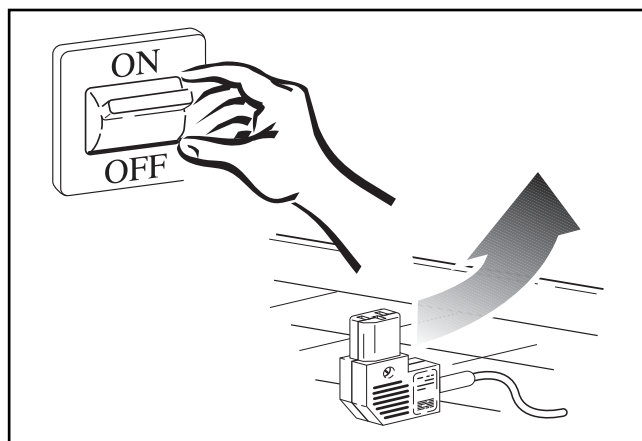

OPERATING ANOMALIES

If the device switches off during normal operation or does not switch on, pressing the On/Off key, the error code (E1, E2, E6, etc.) appears on the display, in this case:

- Check opening of the gas tap.
- Check the electrical power supply is present.
- Take note of the ERROR CODE on the display to understand the type of anomaly.
- Open the device again.
- Reset the device, keeping the On/Off button pressed for 2".

If, despite various attempts, the device stays in "BLOCK" mode, contact the Authorised Technical Support Centre.

Under no circumstances should you fear for domestic safety, since the device is in the "BLOCK" position. Disable the gas supply to the burner, preventing any type of danger. It is a good idea to completely switch off the device as specified in the point "DEVICE SWITCH OFF".

DISPLAY ERROR CODES

When the device is not working, the display flashes to communicate the error code, which would allow you to identify the type of fault:

- E1, Anomalies on SAS probe
- E2, block because the burner does not switch on
- E6, block due to opening of the air pressure switch PS during operation
- E8, non-switching of the air pressure switch PS on start-up
- EA, sticking of the air pressure switch PS on start-up
- EB, communication error with safety device
- E9 - EC - ED - EE, internal safety device faults

⚠ The display with the ERROR CODE continues to flash until the device is reset by pressing the On/Off key.

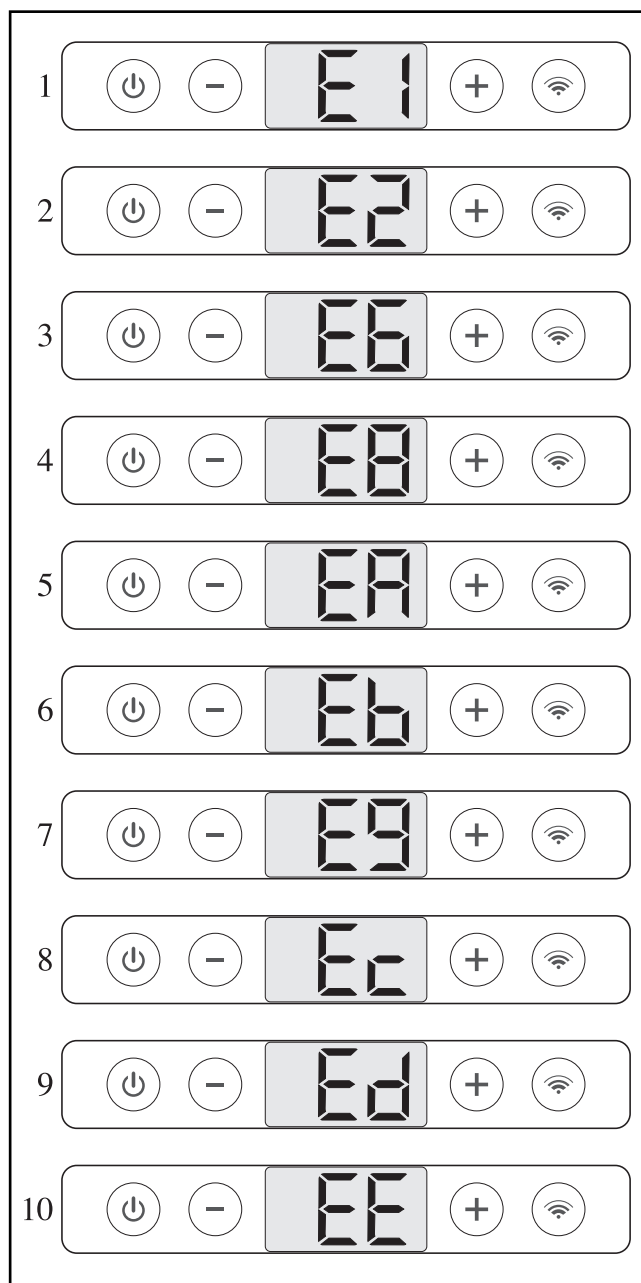
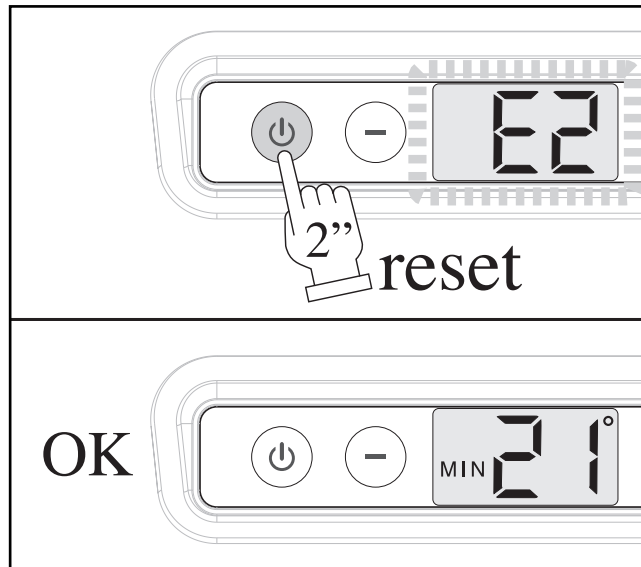

SWITCHING OFF THE APPLIANCE

The appliance can be turned off in “standby” position by means of the On/Off button. In this case, the set program remains stored in the memory. For GENERAL SWITCH-OFF use the master switch on the power supply or disconnect the power plug. The appliance will switch off completely.

⚠ GENERAL switch-off of the appliance must only be done when the convection fan is no longer working after a period of heating operation!

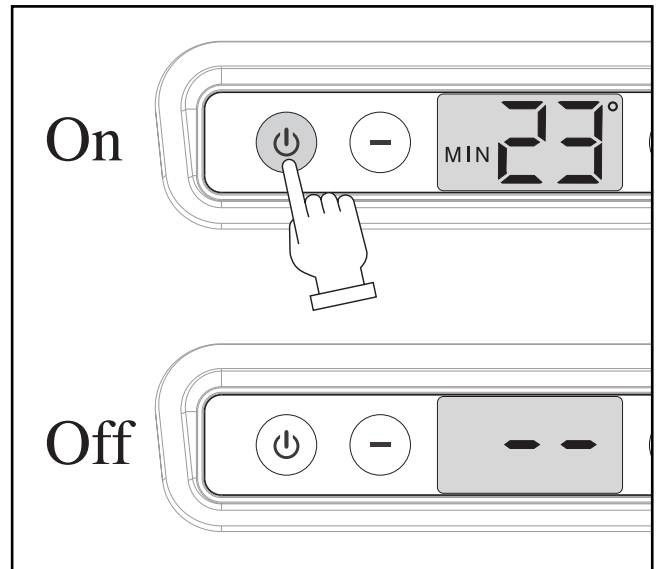

SWITCHING OFF FOR LONG PERIODS

If the appliance is not used for a long period of time, the following operations should be performed:

- Press the On/Off key on board the machine to switch off the appliance.
- Move the omnipolar master switch, if fitted to the system, to “off” or remove the plug from the socket on the appliance;
- Close the gas tap.

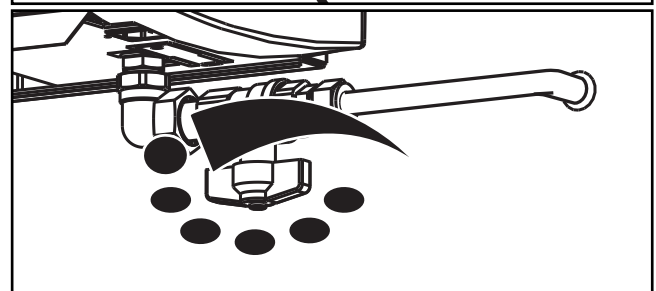
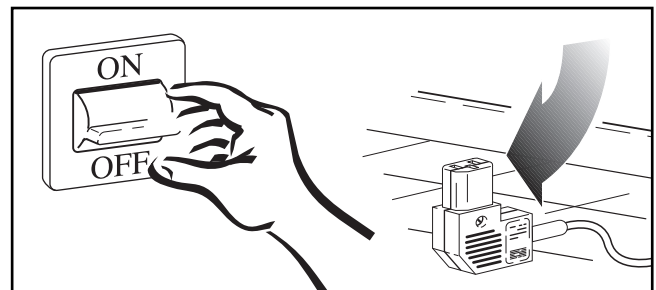

CLEANING THE APPLIANCE

Preliminary operations

- Press the On/Off key on board the machine to switch off the appliance;
- Move the omnipolar master switch, if fitted to the system, to “off” or remove the plug from the socket on the appliance;
- Close the gas tap;
- Wait for the appliance to completely cool down.

Cleaning the outer surfaces

Clean the accessible parts to remove any dust deposits, spider webs and the like.

Use compressed air to blow away the dust, including at hard-to-access points.

To clean the plastic or painted parts, never use solvents or abrasive detergents as these could damage the treated parts.

Use neutral products readily available on the market.

Do not grease the synthetic material parts.

To clean the casing, use a soft cloth soaked in neutral-base home-cleaning products, etc. (Car shampoo, etc.).

 **Do not pour liquid directly onto the casing or onto other parts of the appliance, as this could cause serious damage.**

MAINTENANCE

Please remember that PERIODICAL MAINTENANCE – at least once a year – is essential for the safety, efficiency and long working life of the appliance. It will also result in lower consumption and less polluting emissions.

Maintenance can be periodically performed by the Authorised Technical Assistance Centre, which has all the technical know-how required and, if necessary, original spare parts.

TROUBLESHOOTING

• No power supply

If the appliance fails to start after pressing the On/Off key on the control:

- Make sure the appliance plug is properly inserted in the power socket.
- Make sure the master switch, if fitted, is in “on” position.

If the appliance still fails to start, call the Authorised Technical Assistance Centre.

• BLOCK stop and failed ignition

(see ERROR CODE)

- Make sure the fuel tap is open.
- Restore ignition conditions. Press the On/Off key for 2 seconds to turn the appliance off and back on and wait for all ignition phases to be performed again.

This operation can be repeated 3 times at most and, in the event of its not being successful, position the master switch, where provided, on “off” and contact the Authorised Technical Assistance Centre.

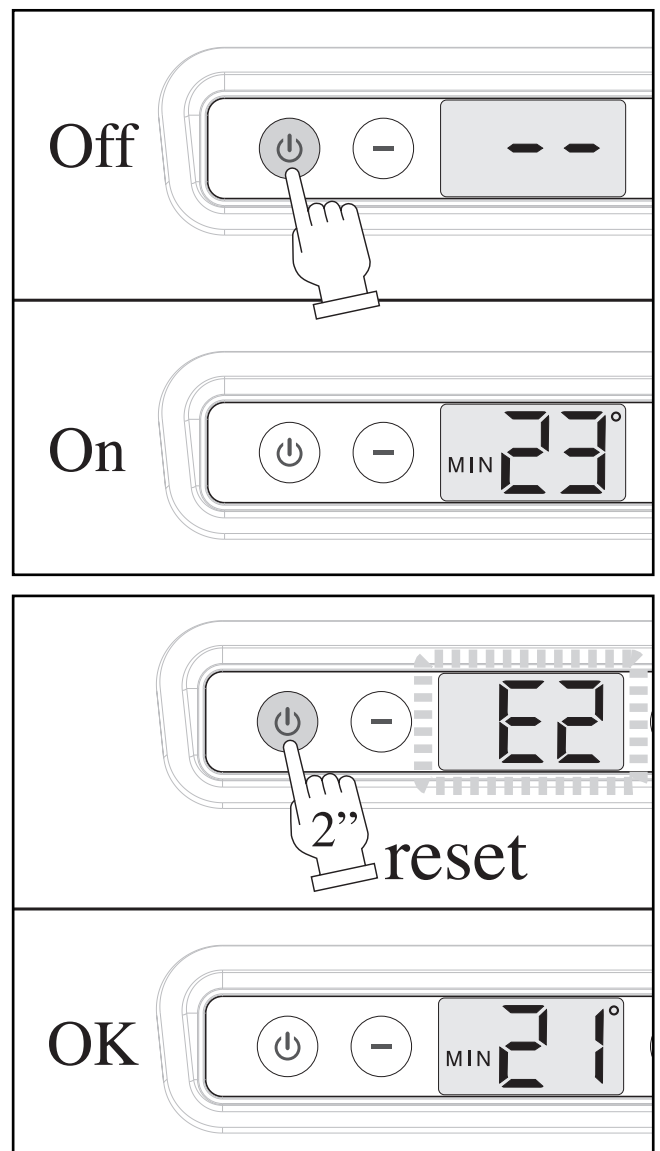

• **No communication between Wireless and appliance**

- Make sure the Wireless and power batteries are working properly.
- Check the distance between the Wireless and the appliance (MAX 10m).
- Make sure the electronic board on the appliance is working properly.

If communication between the device and thermostat remote stops for more than 5 minutes (ex. Batteries), the unit goes into standby mode waiting for a new wireless signal. The unit is not disconnected from ever programmable thermostat remote until the user decides to do so.

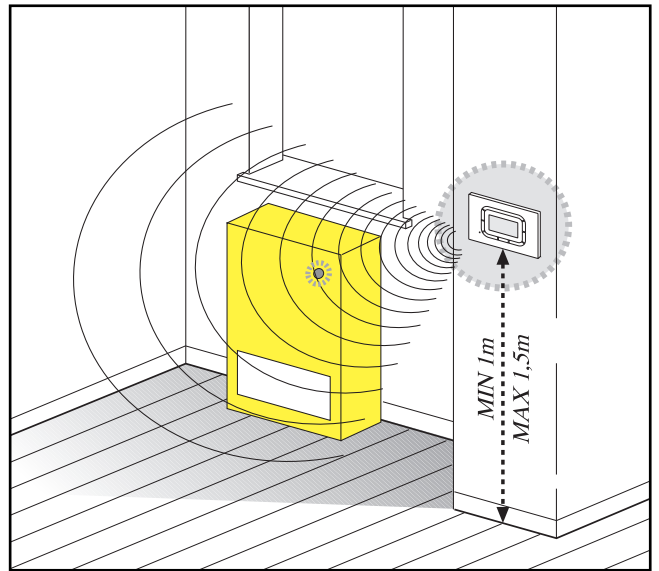

AFTER-SALES SERVICE

Mr.

Street.

Tel.



ITALKERO S.r.l. . via Lumumba 2 . Zona Ind. Torrazzi . 41122 Modena . Italy . Tel +39 59 2550711 . FAX +39 059 4900500 . www.italkero.it

NOTA: Nel continuo perfezionamento del prodotto, le caratteristiche estetiche e dimensionali, i dati tecnici, gli equipaggiamenti e gli accessori, possono essere soggetti a variazione.

NOTE: Due to ongoing product upgrading, aesthetic and dimensional features, technical details, fittings and accessories could undergo changes and are not binding.

NOTE : En vue de l'amélioration continue des produits, les caractéristiques esthétiques et de taille, les données techniques, l'équipement et les accessoires peuvent être modifiés.

HINWEIS: Im Bestreben unsere Produkte kontinuierlich zu verbessern, können maßbezogene und ästhetische Eigenschaften, technische Daten, Ausrüstungen und Anlagen sowie Zubehörkomponenten Veränderungen unterworfen sein.